

CONNECTOR

INC CUSTOMERS GUIDE



MIL-DTL 5015 Type connectors
VG95234 Type INB connectors
MIL-DTL 26482 Series 1 Type connectors



INB Series Connectors

In Accordance With VG95234



Table of Contents	Page
Ordering Information	26
Technical Specifications	26
INB Series	
Wall Mounting Receptacle (INB00A)	27
In-Line Receptacle (INB01A)	27
Box Mounting Receptacle (INB02A)	28
Straight Plug (INB06A)	28
Right Angle Plug (INB08A)	29
Accessories	
Cable Clamp (MS3057A)	29
Other Connector & Cable Assembly	31

Ordering Information

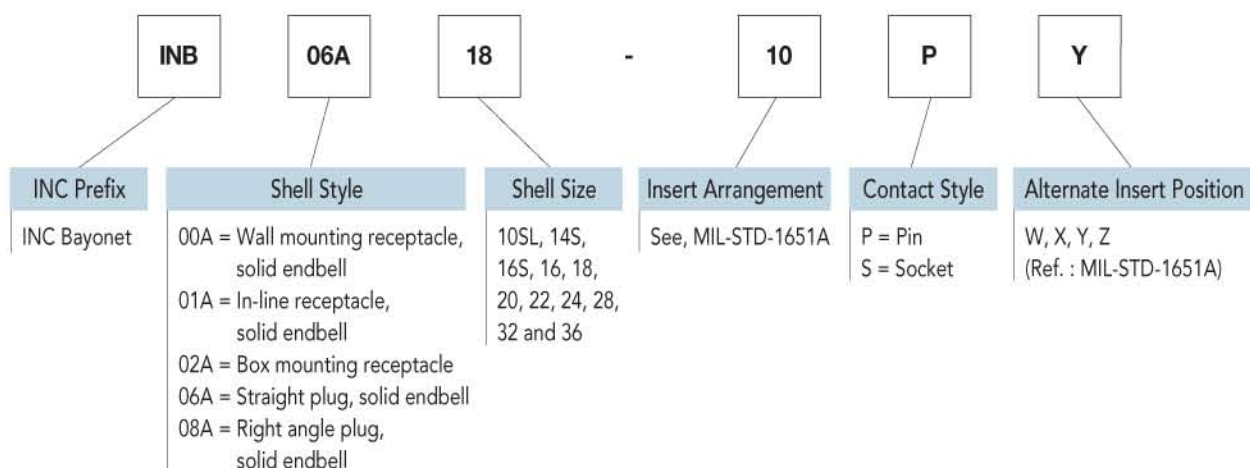

Technical Data

[Materials & Finishes]

Shell, Endbell	Aluminum alloy / Olive drab chromate coating over cadmium or zinc plating
Insulator	Synthetic rubber
Contact	Copper alloy / Silver plating
Roller Stud, Stud Pin	Stainless steel

[Characteristics]

Insulator Resistance	Min. 5000 MΩ at 77°F (+25°C) per MIL-DTL-5015, 3.18
Operating Temperature	-67°F (-55°C) to +257°F (+125°C)
Durability	500 cycles of mating / unmating operations (to VG95234)
Contact Type	Solder or crimp type

Operating Voltage Test Voltage

Service Rating	Operating Voltage DC V	Operating Voltage AC V r.m.s.	Test Voltage AC V r.m.s.	Air Spacing Nominal (Inches)	Creepage Nominal (Inches)
Inst.	250	200	1000	-	1/16
A	700	500	2000	1/16	1/8
D	1250	900	2800	1/8	3/16
E	1750	1250	3500	3/16	1/4
B	2450	1750	4500	1/4	5/16
C	4200	3000	7000	5/16	1

Current Rating at 68°F (+20°C)

Contact Size	Contact Resistance Milliohm Max.	Test Current (Amps)	Potential Drop (Millivolts)
16	16	13	49
12	3	23	42
8	1	46	26
4	0.5	80	23
0	0.2	150	21

Contact Retention & Separation Forces

Contact Size	Axial Load		Separation Force Min.	
	Newtons	Lbs.	Newtons	Lbs.
16	44	10	1	0.25
12	67	15	2	0.50
8	89	20	3	0.75
4	89	20	4	1.00
0	111	25	9	2.00

Insert Arrangement & Alternate Positioning

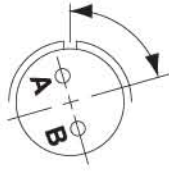

Position W

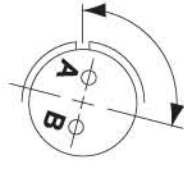

Position X

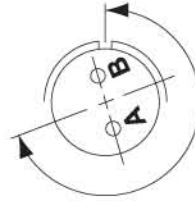

Position Y

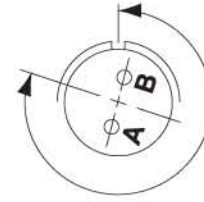

Position Z

View looking into front face of pin insert or rear of socket insert.

Insert Arrangement	Service Rating	Total Contacts	Contact Size					Alternate Position Degrees			
			0	4	8	12	16	W	X	Y	X
10SL-3	A	3					3	-	-	-	-
10SL-4	A	2					2	-	-	-	-
12S-3	A	2					2	70	145	215	290
12S-4	D	1					1	-	-	-	-
14S-1	A	3					3	-	-	-	-
14S-2	Inst.	4					4	-	120	240	-
14S-4	D	1					1	-	-	-	-
14S-5	Inst.	5					5	-	110	-	-
14S-6	Inst.	6					6	-	-	-	-
14S-7	A	3					3	90	180	270	-
14S-9	A	2					2	70	145	215	290
16S-1	A	7					7	80	-	-	280
16S-3	B	1					1	-	-	-	-
16S-4	D	2					2	35	110	250	325
16S-5	A	3					3	70	145	215	290
16S-6	A	3					3	90	180	270	-
16S-8	A	5					5	-	170	265	-
16-2	E	1				1		-	-	-	-
16-7	A	3			1		2	80	110	250	280
16-9	A	4				2	2	35	110	250	325
16-10	A	3				3		90	180	270	-
16-11	A	2				2		35	110	250	325
16-12	A	1		1				-	-	-	-
16-13	A	2				2		35	110	250	325
18-1	A/Inst.	10					10	70	145	215	290
18-3	D	2				2		35	110	250	325
18-4	D	4				4		35	110	250	325
18-5	D	3				2	1	80	110	250	280
18-6	D	1		1				-	-	-	-
18-7	B	1			1			-	-	-	-
18-8	A	8				1	7	70	-	-	290
18-9	Inst.	7				2	5	80	110	250	280
18-10	A	4				4		-	120	240	-
18-11	A	5				5		-	170	265	-
18-12	A	6				6		80	-	-	280
18-13	A	4			1	3		80	110	250	280
18-14	A	2		1			1	80	110	250	280
18-15	A	4				4		-	120	240	-
18-16	C	1				1		-	-	-	-

Insert Arrangement	Service Rating	Total Contacts	Contact Size					Alternate Position Degrees				
			0	4	8	12	16	W	X	Y	X	
18-20	A	5					5	90	180	270	-	
18-22	D	3					3	70	145	215	290	
18-29	A	5					5	90	180	270	-	
20-3	D	3				3		70	145	215	290	
20-4	D	4				4		45	110	250	-	
20-6	D	3					3	70	145	215	290	
20-7	D/A	8					8	80	110	250	280	
20-8	Inst.	6			2		4	80	110	250	280	
20-9	D/A	8				1	7	80	110	250	280	
20-11	Inst.	13					13	-	-	-	-	
20-12	A	2		1			1	80	110	250	280	
20-14	A	5			2	3		80	110	250	280	
20-15	A	7				7		80	-	-	280	
20-16	A	9				2	7	80	110	250	280	
20-17	A	6				5	1	90	180	270	-	
20-18	A	9				3	6	35	110	250	325	
20-19	A	3				3		90	180	270	-	
20-20	A	4		1			3	80	110	250	280	
20-21	A	9				1	8	35	110	250	325	
20-22	A	6				3	3	80	110	250	280	
20-23	A	2				2		35	110	250	325	
20-24	A	4				2	2	35	110	250	325	
20-27	A	14					14	35	110	250	325	
20-29	A	17					17	80	-	-	280	
20-33	A	11					11	-	-	-	-	
22-1	D	2				2		35	110	250	325	
22-2	D	3				3		70	145	215	290	
22-4	A	4				2	2	35	110	250	325	
22-5	D	6					2	4	35	110	250	325
22-6	D	3				2	1	80	110	250	280	
22-7	E	1		1				-	-	-	-	
22-8	E	2				2		35	110	250	325	
22-9	E	3				3		70	145	215	290	
22-10	E	4					4	35	110	250	325	
22-11	B	2					2	35	110	250	325	
22-12	D	5				2	3	80	110	250	280	
22-13	D/A	5				4	1	35	110	250	325	
22-14	A	19					19	80	110	250	280	
22-15	E/A	6				5	1	80	110	250	280	

Insert Arrangement & Alternate Positioning

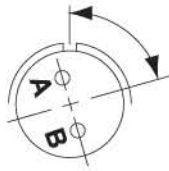

Position W

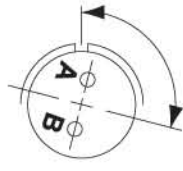

Position X

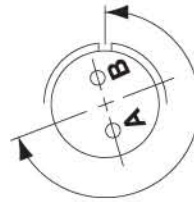

Position Y

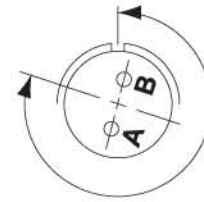

Position Z

View looking into front face of pin insert or rear of socket insert.

Insert Arrangement	Service Rating	Total Contacts	Contact Size					Alternate Position Degrees			
			0	4	8	12	16	W	X	Y	X
22-16	A	9				3	6	80	110	250	280
22-17	D/A	9				1	8	80	110	250	280
22-18	A/D	8					8	80	110	250	280
22-19	A	14					14	80	110	250	280
22-20	A	9					9	35	110	250	325
22-21	A	3	1				2	80	110	250	280
22-22	A	4			4			-	110	250	-
22-23	D/A	8				8		35	-	250	-
22-24	D/A	6				2	4	80	110	250	280
22-27	D/A	9			1		8	80	-	250	280
22-28	A	7				7		80	-	-	280
22-33	A/D	7					7	80	110	250	280
22-34	D	5				3	2	80	110	250	280
22-36	D/A	8				8		90	-	270	-
24-2	D	7				7		80	-	-	280
24-3	D	7				2	5	80	110	250	280
24-5	A	16					16	80	110	250	280
24-6	D/A	8				8		80	110	250	280
24-7	A	16				2	14	80	110	250	280
24-9	A	2		2				35	110	250	325
24-10	A	7			7			80	-	-	280
24-11	A	9			3	6		35	110	250	325
24-12	A	5		2		3		80	110	250	280
24-16	D/A	7			1	3	3	80	110	250	280
24-17	D	5				2	3	80	110	250	280
24-20	D	11				2	9	80	110	250	280
24-21	D	10			1		9	80	110	250	280
24-22	D	4			4			45	110	250	-
24-27	E	7				7		80	-	-	280
24-28	Inst.	24					24	80	110	250	280
28-1	D/A	9			3	6		80	110	250	280
28-2	D	14				2	12	35	110	250	325
28-3	E	3			3			70	145	215	290
28-4	E/D	9				2	7	80	110	250	280
28-5	D	5		2		1	2	35	110	250	325
28-6	D	3		3				70	145	215	290
28-8	E/D/A	12				2	10	80	110	250	280
28-9	D	12				6	6	80	110	250	280
28-10	D/A	7		2	2	3		80	110	250	280

Insert Arrangement	Service Rating	Total Contacts	Contact Size					Alternate Position Degrees				
			0	4	8	12	16	W	X	Y	X	
28-11	A	22				4	18	80	110	250	280	
28-12	A	26					26	90	180	270	-	
28-15	A	35					35	80	110	250	280	
28-16	A	20					20	80	110	250	280	
28-17	B/D/A	15					15	80	110	250	280	
28-18	C/A/Inst/D	12					12	70	145	215	290	
28-19	B/D/A	10				4	6	80	110	250	280	
28-20	A	14					10	4	80	110	250	280
28-21	A	37					37	80	110	250	280	
28-22	D	6		3			3	70	145	215	290	
32-1	E/D	5	2				3	80	110	250	280	
32-2	E	5		3			2	70	145	215	290	
32-3	D	9	1	2		2	4	80	110	250	280	
32-4	D/A	14				2	12	80	110	250	280	
32-5	D	2	2					80	110	250	325	
32-6	A	23		2	3	2	16	80	110	250	280	
32-7	Inst./A	35				7	28	80	125	235	280	
32-8	A	30				6	24	80	125	235	280	
32-9	D	14		2			12	80	110	250	280	
32-10	E/B/D/A	7		2	2		3	80	110	250	280	
32-12	A/D	15				5	10	80	110	250	280	
32-13	D	23				5	18	80	110	250	280	
32-15	D	8	2			6		35	110	250	280	
32-17	D	4		4				45	110	250	-	
36-1	D	22				4	18	80	110	250	280	
36-3	D	6	3			3		70	145	215	290	
36-4	D/A	3	3					70	145	215	290	
36-5	A	4	4					-	120	240	-	
36-6	A	6	2	4				35	110	250	325	
36-7	A	47				7	40	80	110	250	280	
36-8	A	47				1	46	80	110	250	280	
36-9	A	31		1	2	14	14	80	125	235	280	
36-10	A	48					48	80	125	235	280	
36-13	E/A	17				2	15	80	110	250	280	
36-14	D	16			5	5	6	90	180	270	-	
36-15	D/A	35					35	60	125	245	305	
36-52	A	52					52	72	144	216	288	

Contact Arrangement

Front face of pin insert or rear face of socket insert illustrated.

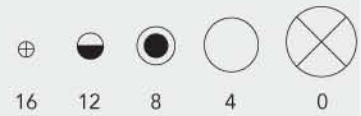

1 CONTACT

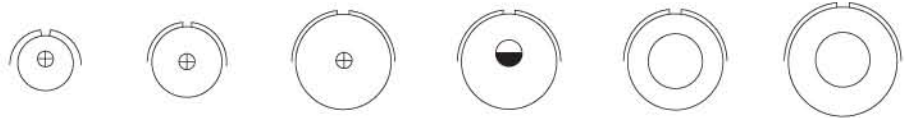

Insert Arrangement	12S-4	14S-4	16S-3	16-2	16-12	18-6
Contact Size - No. of Contacts	#16-1	#16-1	#16-1	#12-1	#4-1	#4-1
Service Rating	D	D	B	E	A	D



Insert Arrangement	18-7	18-16	22-7
Contact Size - No. of Contacts	#8-1	#12-1	#0-1
Service Rating	B	C	E

2 CONTACTS

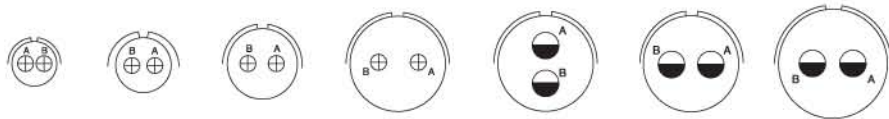

Insert Arrangement	10SL-4	12S-3	14S-9	16S-4	16-11	16-13	18-3
Contact Size - No. of Contacts	#16-2	#16-2	#16-2	#16-2	#12-2	#12-2	#12-2
Service Rating	A	A	A	D	A	A	D

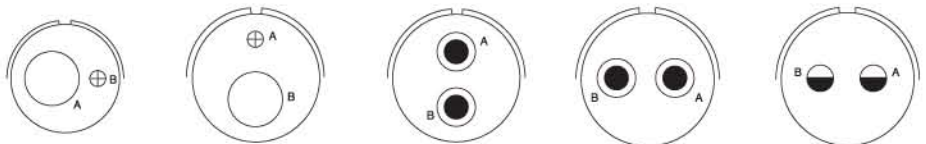

Insert Arrangement	18-14	20-12	20-23	22-1	22-8
Contact Size - No. of Contacts	#16-1, #4-1	#16-1, #4-1	#8-2	#8-2	#12-2
Service Rating	A	A	A	D	E

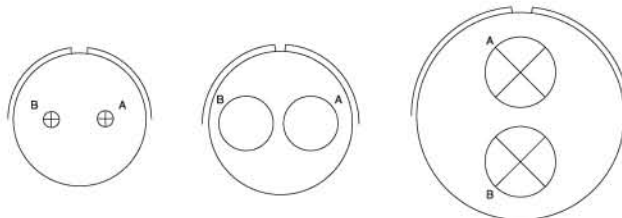

Insert Arrangement	22-11	24-9	32-5
Contact Size - No. of Contacts	#16-2	#4-2	#0-2
Service Rating	B	A	D

Contact Arrangement

Front face of pin insert or rear face of socket insert illustrated.



CONTACT LEGEND

16

12

8

4

0

3 CONTACTS

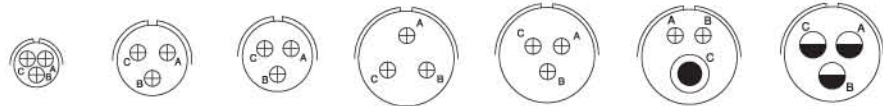

Insert Arrangement	10SL-3	14S-1	14S-7	16S-5	16S-6	16-7	16-10
Contact Size - No. of Contacts	#16-3	#16-3	#16-3	#16-3	#16-3	#16-2, #8-1	#12-3
Service Rating	A	A	A	A	A	A	A

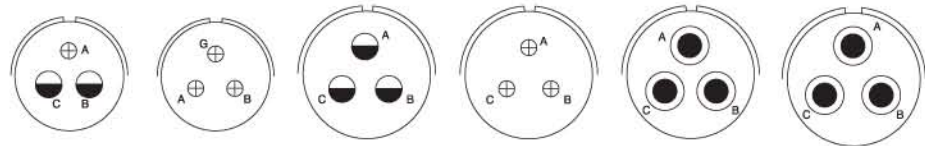

Insert Arrangement	18-5	18-22	20-3	20-6	20-19	22-2
Contact Size - No. of Contacts	#16-1, #12-2	#16-3	#12-3	#16-3	#8-3	#8-3
Service Rating	D	D	D	D	A	D

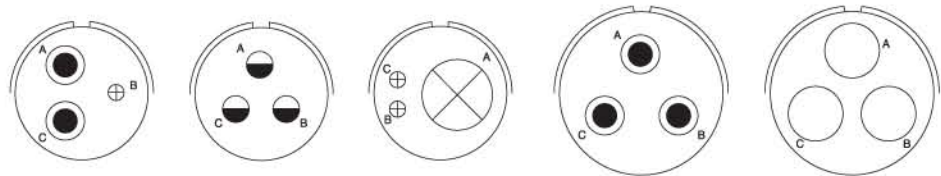

Insert Arrangement	22-6	22-9	22-21	28-3	28-6
Contact Size - No. of Contacts	#16-1, #8-2	#12-3	#16-2, #0-1	#8-3	#4-3
Service Rating	D	E	A	E	D

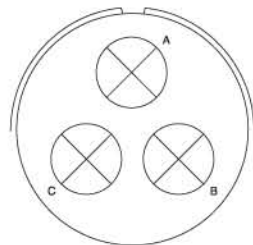

Insert Arrangement	36-4
Contact Size - No. of Contacts	#0-3
Service Rating	D(A) / A(B,C)

4 CONTACTS



Insert Arrangement	14S-2	16-9	18-4	18-10	18-13	18-15
Contact Size - No. of Contacts	#16-4	#16-2, #12-2	#16-4	#12-4	#12-3, #8-1	#12-4
Service Rating	Inst.	A	D	A	A	A

Contact Arrangement

Front face of pin insert or rear face of socket insert illustrated.

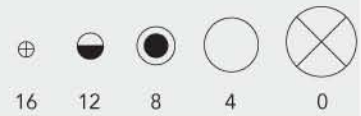

4 CONTACTS

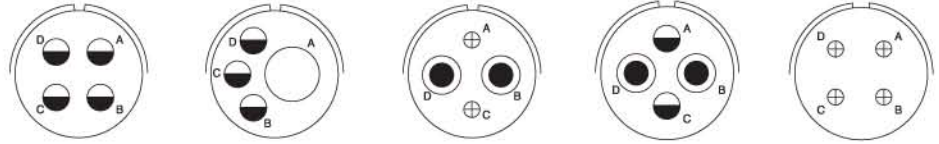

Insert Arrangement	20-4	20-20	20-24	22-4	22-10
Contact Size - No. of Contacts	#12-4	#12-3, #4-1	#16-2, #8-2	#12-2, #8-2	#16-4
Service Rating	D	A	A	A	E

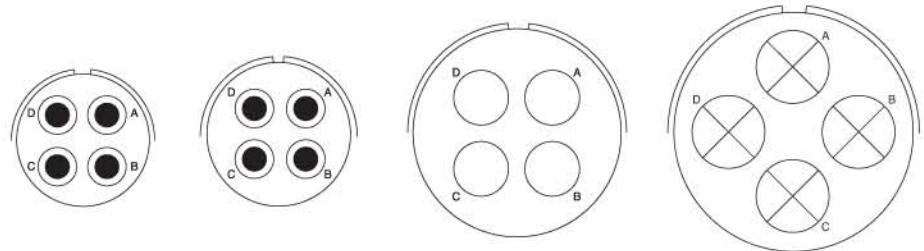

Insert Arrangement	22-22	24-22	32-17	36-5
Contact Size - No. of Contacts	#8-4	#8-4	#4-4	#0-4
Service Rating	A	D	D	A

5 CONTACTS

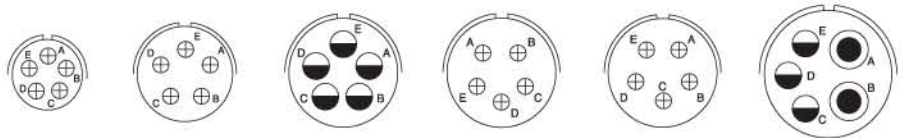

Insert Arrangement	14S-5	16S-8	18-11	18-20	18-29	20-14
Contact Size - No. of Contacts	#16-5	#16-5	#12-5	#16-5	#16-5	#12-3, #8-2
Service Rating	Inst.	A	A	A	A	A

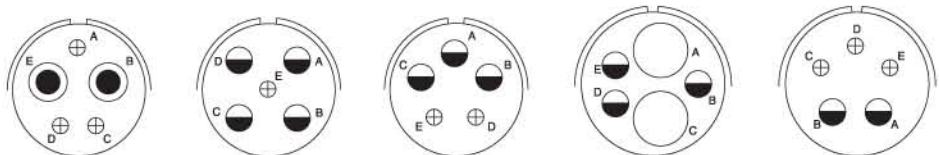

Insert Arrangement	22-12	22-13	22-34	24-12	24-17
Contact Size - No. of Contacts	#16-3, #8-2	#16-1, #12-4	#16-2, #12-3	#12-3, #4-2	#16-3, #12-2
Service Rating	D	D(E) / A(All others)	D	A	D

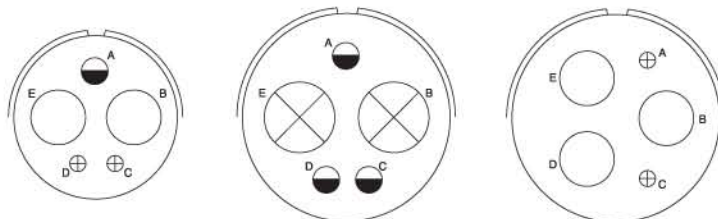

Insert Arrangement	28-5	32-1	32-2
Contact Size - No. of Contacts	#16-2, #12-1, #4-2	#12-3, #0-2	#16-2, #4-3
Service Rating	D	E(A) / D(All others)	E

Contact Arrangement

Front face of pin insert or rear face of socket insert illustrated.



6 CONTACTS

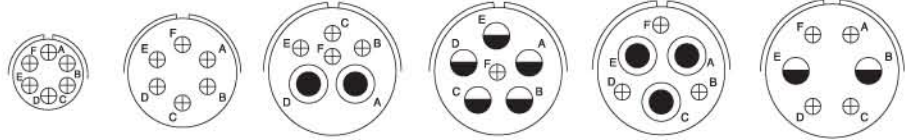

Insert Arrangement	14S-6	18-12	20-8	20-17	20-22	22-5
Contact Size - No. of Contacts	#16-6	#16-6	#16-4, #8-2	#16-1, #12-5	#16-3, #8-3	#16-4, #12-2
Service Rating	Inst.	A	Inst.	A	A	D

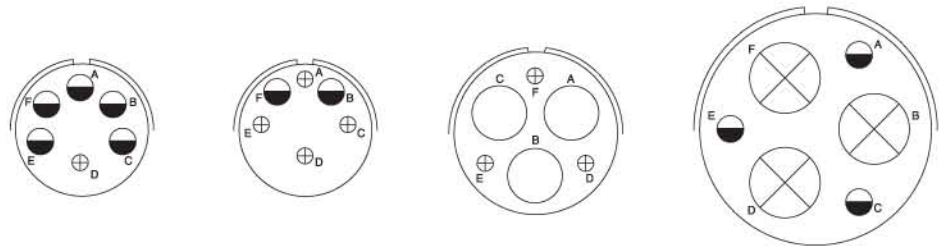

Insert Arrangement	22-15	22-24	28-22	36-3
Contact Size - No. of Contacts	#16-1, #12-5	#16-4, #12-2	#16-3, #4-3	#12-3, #0-3
Service Rating	E(D) / A(All others)	D(C, D, E) / A(All others)	D	D

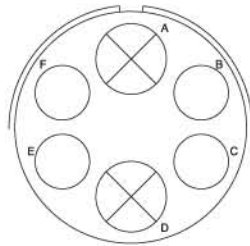

Insert Arrangement	36-6
Contact Size - No. of Contacts	#4-4, #0-2
Service Rating	A

7 CONTACTS

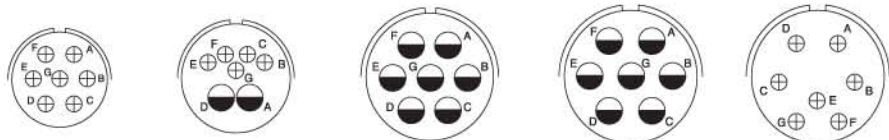

Insert Arrangement	16S-1	18-9	20-15	22-28	22-33
Contact Size - No. of Contacts	#16-7	#16-5, #12-2	#12-7	#12-7	#16-7
Service Rating	A	Inst	A	A	A(E, F, G) / D(All others)

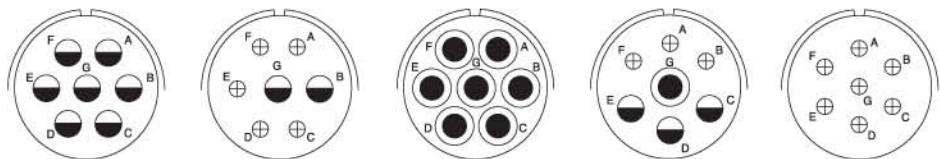

Insert Arrangement	24-2	24-3	24-10	24-16	24-27
Contact Size - No. of Contacts	#12-7	#16-5, #12-2	#8-7	#16-3, #12-3, #8-1	#16-7
Service Rating	D	D	A	D(A, B, F, G) / A(All others)	E

Contact Arrangement

Front face of pin insert or rear face of socket insert illustrated.



CONTACT LEGEND

16 12 8 4 0

7 CONTACTS

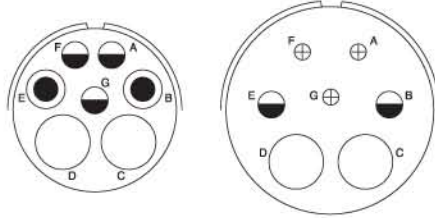

Insert Arrangement	28-10	32-10
Contact Size - No. of Contacts	#12-3, #8-2, #4-2	#16-3, #8-2, #4-2
Service Rating	D(G) / A(Bal.)	E(A, F) / B(G) / D(B, E) / A(C, D)

8 CONTACTS

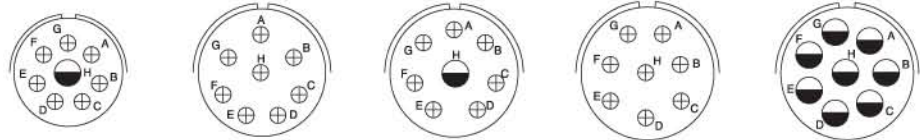

Insert Arrangement	18-8	20-7	20-9	22-18	22-23
Contact Size - No. of Contacts	#16-7, #12-1	#16-8	#16-7, #12-1	#16-8	#12-8
Service Rating	A	D(A, B, H, G) / A(All others)	D(H) / A(All others)	A(C, D, E) / D(All others)	D(H) / A(All others)

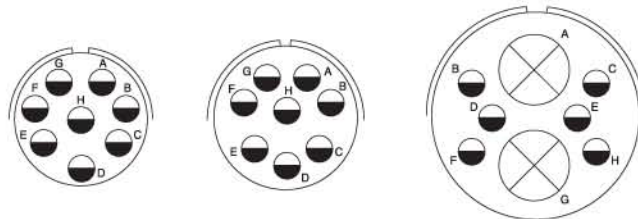

Insert Arrangement	22-36	24-6	32-15
Contact Size - No. of Contacts	#12-8	#12-8	#16-6, #0-2
Service Rating	D(H) / A(All others)	D(A, G, H) / A(All others)	D

9 CONTACTS

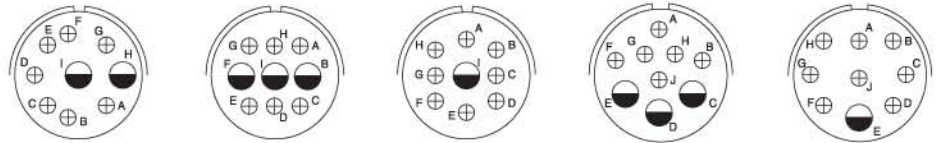

Insert Arrangement	20-16	20-18	20-21	22-16	22-17
Contact Size - No. of Contacts	#16-7, #12-2	#16-6, #12-3	#16-8, #12-1	#16-6, #12-3	#16-8, #12-1
Service Rating	A	A	A	A	D(A) / A(All others)

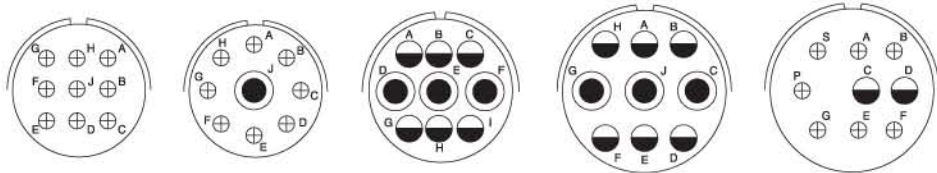

Insert Arrangement	22-20	22-27	24-11	28-1	28-4
Contact Size - No. of Contacts	#16-9	#16-8, #8-1	#12-6, #8-3	#12-6, #8-3	#16-7, #12-2
Service Rating	A	D(J) / A(All others)	A	D(A, J, E) / A(Bal.)	E(G, P, S) / D(Bal.)

Contact Arrangement

Front face of pin insert or rear face of socket insert illustrated.



CONTACT LEGEND

16 12 8 4 0

MIL-DTL-5015 Type

9 CONTACTS

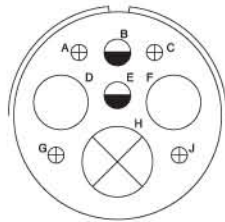

Insert Arrangement	32-3
Contact Size - No. of Contacts	#16-4, #12-2, #4-2, #0-1
Service Rating	D

10 CONTACTS

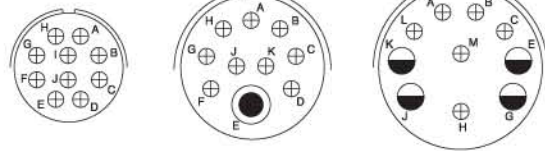

18-1	24-21	28-19
#16-10	#16-9, #8-1	#16-6, #12-4
A(B, C, F, G) / Inst.(All others)	D	B(H, M) / D(A, B) / A(All others.)

11 CONTACTS

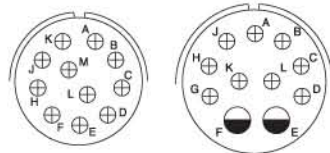

Insert Arrangement	20-33	24-20
Contact Size - No. of Contacts	#16-11	#16-9, #12-2
Service Rating	A	D

12 CONTACTS

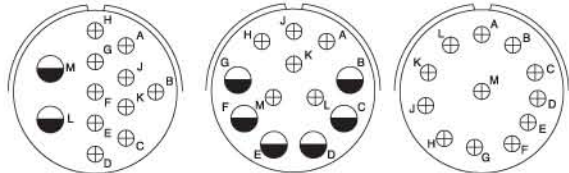

28-8	28-9	28-18
#16-10, #12-2	#16-6, #12-6	#16-12
E(L, M) / D(B) / A(All others)	D	C(M) / A(A, B) Inst.(C, D, E, F) / D(All others)

13 CONTACTS

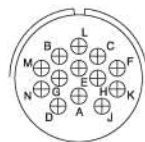

Insert Arrangement	20-11
Contact Size - No. of Contacts	#16-13
Service Rating	Inst.

14 CONTACTS

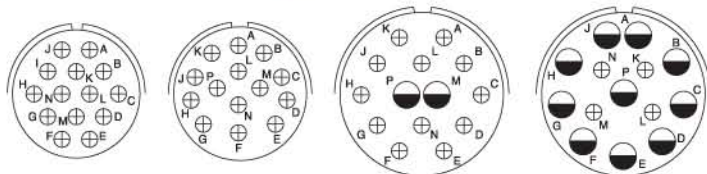

20-27	22-19	28-2	28-20
#16-14	#16-14	#16-12, #12-2	#16-4, #12-10
A	A	D	A

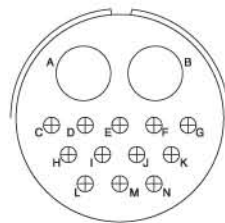
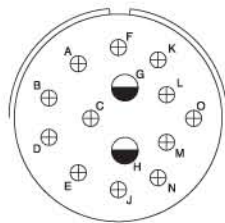

Insert Arrangement	32-4	32-9
Contact Size - No. of Contacts	#16-12, #12-2	#16-12, #4-2
Service Rating	A(F, J, K, N) / D(Bal.)	D

Contact Arrangement

Front face of pin insert or rear face of socket insert illustrated.



CONTACT LEGEND

16 12 8 4 0

15 CONTACTS

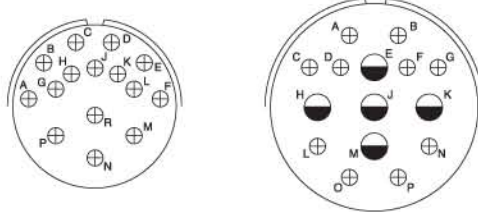

Insert Arrangement	28-17	32-12
Contact Size - No. of Contacts	#16-15	#16-10, #12-5
Service Rating	B(R) / D(M, N, P) / A(All others)	A(C, D, E, F, G) / D(Bal.)

16 CONTACTS

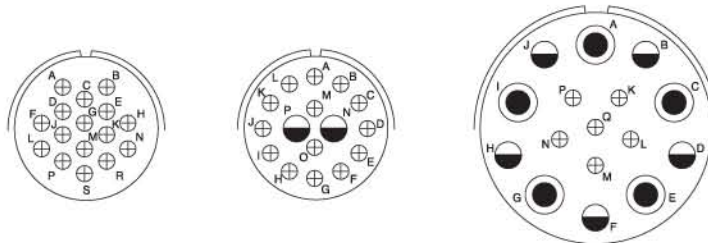

Insert Arrangement	24-5	24-7	36-14
Contact Size - No. of Contacts	#16-16	#16-14, #12-2	#16-6, #12-5, #8-5
Service Rating	A	A	D

17 CONTACTS

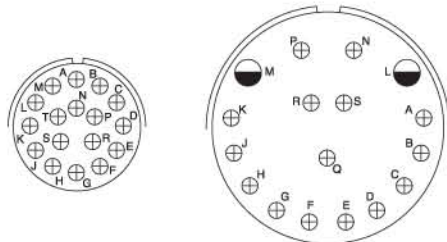

Insert Arrangement	20-29	36-13
Contact Size - No. of Contacts	#16-17	#16-15, #12-2
Service Rating	A	E(N, P, Q) / A(All others.)

19 CONTACTS

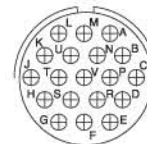

Insert Arrangement	22-14
Contact Size - No. of Contacts	#16-19
Service Rating	A

20 CONTACTS

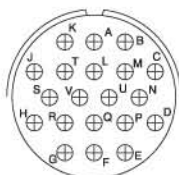

Insert Arrangement	28-16
Contact Size - No. of Contacts	#16-20
Service Rating	A

22 CONTACTS

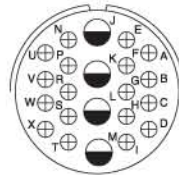

Insert Arrangement	28-11	36-1
Contact Size - No. of Contacts	#16-18, #12-4	#16-18, #12-4
Service Rating	A	D

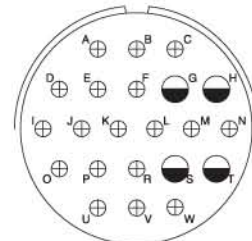

Contact Arrangement

Front face of pin insert or rear face of socket insert illustrated.



23 CONTACTS

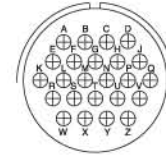
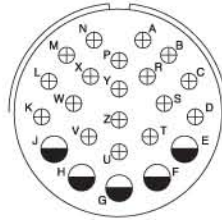
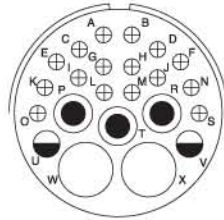

24 CONTACTS

Insert Arrangement	32-6	32-13
Contact Size - No. of Contacts	#16-16, #12-2, #8-3, #4-2	#16-18, #12-5
Service Rating	A	D

Insert Arrangement	24-28
Contact Size - No. of Contacts	#16-24
Service Rating	Inst.

26 CONTACTS

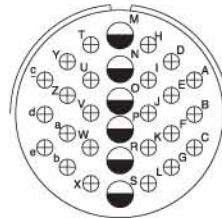
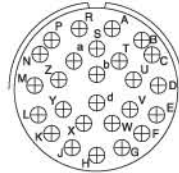

31 CONTACTS

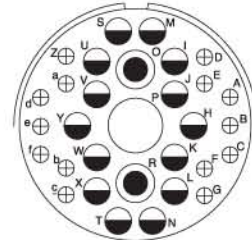

Insert Arrangement	28-12
Contact Size - No. of Contacts	#16-26
Service Rating	A

Insert Arrangement	32-8
Contact Size - No. of Contacts	#16-24, #12-6
Service Rating	A

Insert Arrangement	36-9
Contact Size - No. of Contacts	#16-14, #12-14, #8-2, #4-1
Service Rating	A

35 CONTACTS

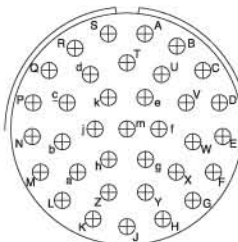
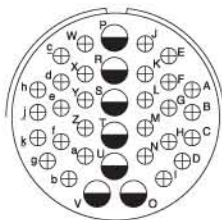
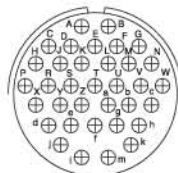

37 CONTACTS

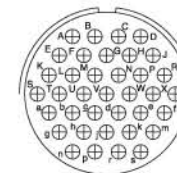

Insert Arrangement	28-15	32-7	36-15
Contact Size - No. of Contacts	#16-35	#16-28, #12-7	#16-35
Service Rating	A	Inst.(A, B, h, j) / A(All others)	D(M) / A(All others)

Insert Arrangement	28-21
Contact Size - No. of Contacts	#16-37
Service Rating	A

47 CONTACTS

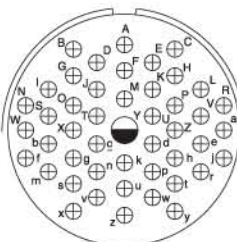
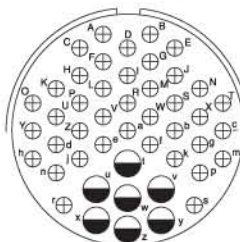

48 CONTACTS

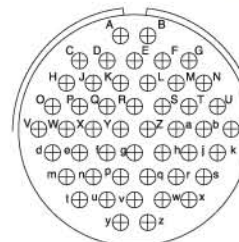

52 CONTACTS

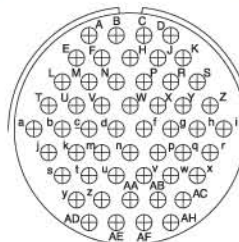

Insert Arrangement	36-7	36-8
Contact Size - No. of Contacts	#16-40, #12-7	#16-46, #12-1
Service Rating	A	A

Insert Arrangement	36-10
Contact Size - No. of Contacts	#16-48
Service Rating	A

Insert Arrangement	36-52
Contact Size - No. of Contacts	#16-52
Service Rating	A

INB00A Wall Mounting Receptacle

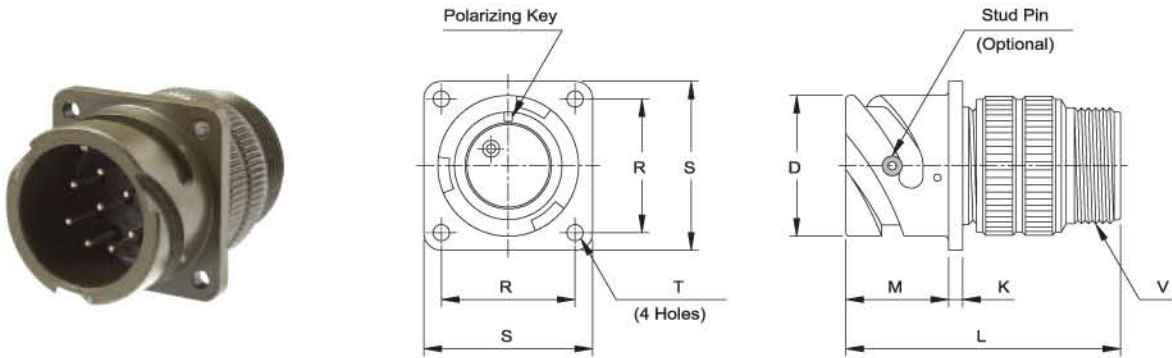

Part No.	D dia. +0.00 -0.15	K min./max.	L Ref.	M +0.79 -0.00	R ±0.12	S ±0.79	T dia. +0.25 -0.12	V Thread Class 2A
INB00A 10SL-*	18.20	1.58 / 3.96	38.88	14.28	18.26	25.40	3.05	5/8-24 UNEF
INB00A 14S-*	24.60	1.58 / 3.96	42.87	14.28	23.01	30.18	3.05	3/4-20 UNEF
INB00A 16S-*	27.40	1.58 / 3.96	42.87	14.28	24.61	32.54	3.05	7/8-20 UNEF
INB00A 16-*	27.40	1.58 / 3.96	52.37	19.05	24.61	32.54	3.05	7/8-20 UNEF
INB00A 18-*	30.80	2.39 / 5.15	52.37	19.05	26.97	34.93	3.05	1-20 UNEF
INB00A 20-*	34.20	2.39 / 5.15	55.57	19.05	29.36	38.10	3.05	1 3/16-18 UNEF
INB00A 22-*	37.40	2.39 / 5.15	55.57	19.05	31.75	41.28	3.05	1 3/16-18 UNEF
INB00A 24-*	40.90	2.39 / 5.15	58.72	20.63	34.93	44.45	3.73	1 7/16-18 UNEF
INB00A 28-*	46.70	2.39 / 5.15	58.72	20.63	39.67	50.80	3.73	1 7/16-18 UNEF
INB00A 32-*	53.40	3.18 / 9.11	61.92	22.23	44.45	57.15	4.39	1 3/4-18 UNS
INB00A 36-*	59.60	3.18 / 9.11	61.92	22.23	49.23	63.50	4.39	2-18 UNS

INB01A In-Line Receptacle

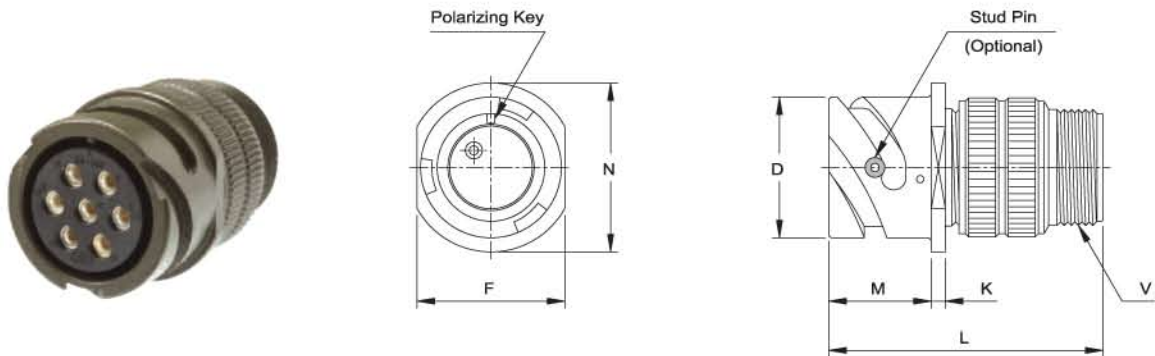

Part No.	D dia. +0.00 -0.15	F Ref.	K min./max.	L Ref.	M +0.79 -0.00	N dia. max.	V Thread Class 2A
INB01A 10SL-*	18.20	16.66	1.58 / 3.96	38.88	14.28	24.61	5/8-24 UNEF
INB01A 14S-*	24.60	22.61	1.58 / 3.96	42.87	14.28	29.36	3/4-20 UNEF
INB01A 16S-*	27.40	25.78	1.58 / 3.96	42.87	14.28	31.75	7/8-20 UNEF
INB01A 16-*	27.40	25.78	1.58 / 3.96	52.37	19.05	31.75	7/8-20 UNEF
INB01A 18-*	30.80	28.96	2.39 / 5.15	52.37	19.05	34.13	1-20 UNEF
INB01A 20-*	34.20	32.13	2.39 / 5.15	55.57	19.05	37.31	1 3/16-18 UNEF
INB01A 22-*	37.40	35.31	2.39 / 5.15	55.57	19.05	40.48	1 3/16-18 UNEF
INB01A 24-*	40.90	38.48	2.39 / 5.15	58.72	20.63	43.66	1 7/16-18 UNEF
INB01A 28-*	46.70	44.83	2.39 / 5.15	58.72	20.63	50.01	1 7/16-18 UNEF
INB01A 32-*	53.40	51.18	3.18 / 9.11	61.92	22.23	56.36	1 3/4-18 UNS
INB01A 36-*	59.60	57.66	3.18 / 9.11	61.92	22.23	62.71	2-18 UNS

INB02A Box Mounting Receptacle

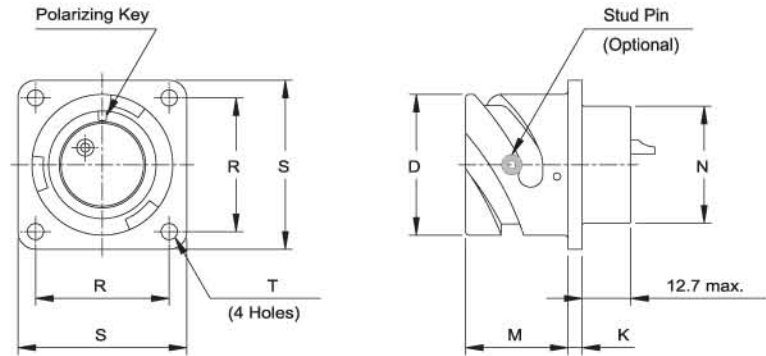

Part No.	D dia. +0.00 -0.15	K min./max.	M +0.79 -0.00	N dia. +0.00 -4.78	R ±0.12	S ±0.79	T dia. +0.25 -0.12
INB02A 10SL-*	18.20	1.58 / 3.96	14.28	19.86	18.26	25.40	3.05
INB02A 14S-*	24.60	1.58 / 3.96	14.28	23.01	23.01	30.18	3.05
INB02A 16S-*	27.40	1.58 / 3.96	14.28	26.21	24.61	32.54	3.05
INB02A 16-*	27.40	1.58 / 3.96	19.05	26.21	24.61	32.54	3.05
INB02A 18-*	30.80	2.39 / 5.15	19.05	29.36	26.97	34.93	3.05
INB02A 20-*	34.20	2.39 / 5.15	19.05	32.56	29.36	38.10	3.05
INB02A 22-*	37.40	2.39 / 5.15	19.05	35.71	31.75	41.28	3.05
INB02A 24-*	40.90	2.39 / 5.15	20.63	38.91	34.93	44.45	3.73
INB02A 28-*	46.70	2.39 / 5.15	20.63	45.26	39.67	50.80	3.73
INB02A 32-*	53.40	3.18 / 9.11	22.23	51.61	44.45	57.15	4.39
INB02A 36-*	59.60	3.18 / 9.11	22.23	57.96	49.23	63.50	4.39

INB06A Straight Plug

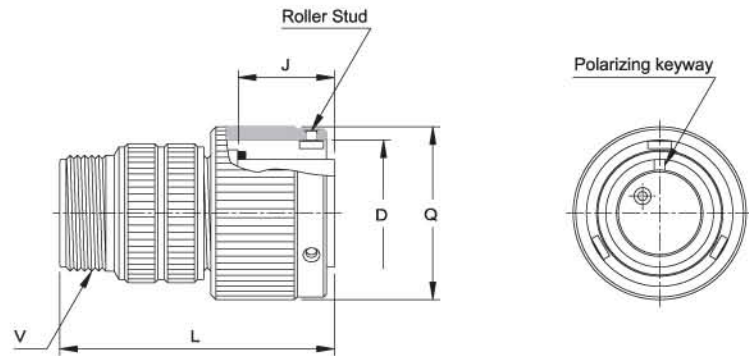

Part No.	D dia. +0.2 -0.0	J ±0.12	L Ref.	Q dia. Ref.	V Thread Class 2A
INB06A 10SL-*	18.4	13.49	38.88	22.8	5/8-24 UNEF
INB06A 14S-*	24.8	13.49	42.87	29.2	3/4-20 UNEF
INB06A 16S-*	27.6	13.49	42.87	32.0	7/8-20 UNEF
INB06A 16-*	27.6	18.26	52.37	32.0	7/8-20 UNEF
INB06A 18-*	31.1	18.26	52.37	36.5	1-20 UNEF
INB06A 20-*	34.5	18.26	55.57	39.9	1 3/16-18 UNEF
INB06A 22-*	37.7	18.26	55.57	43.1	1 3/16-18 UNEF
INB06A 24-*	41.2	18.26	58.72	46.5	1 7/16-18 UNEF
INB06A 28-*	47.0	18.26	58.72	53.4	1 7/16-18 UNEF
INB06A 32-*	53.7	18.26	61.92	60.1	1 3/4-18 UNS
INB06A 36-*	59.9	18.26	61.92	66.3	2-18 UNS

INB08A Right Angle Plug

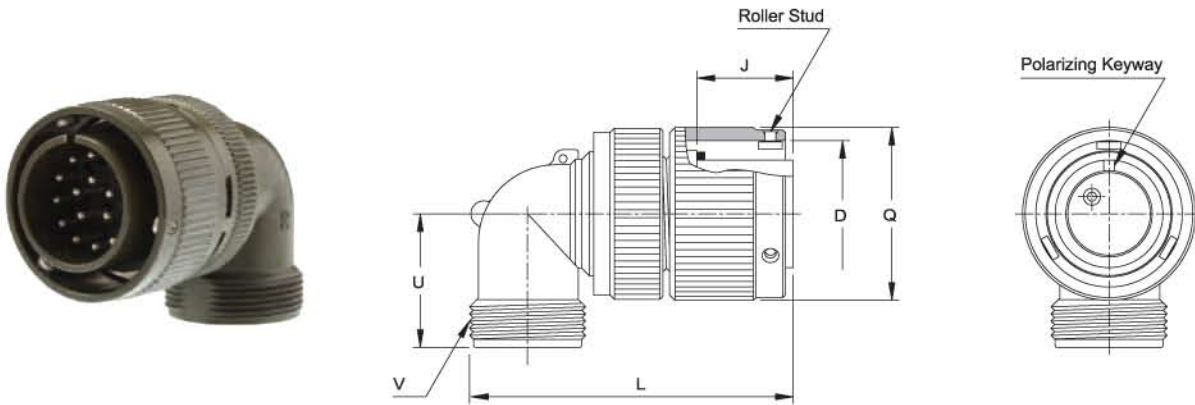

Part No.	D dia. +0.2 -0.0	J ±0.12	L Ref.	Q dia. Ref.	U max.	V Thread Class 2A
INB08A 10SL-*	18.4	13.49	46.02	22.8	25.40	5/8-24 UNEF
INB08A 14S-*	24.8	13.49	53.97	29.2	28.57	3/4-20 UNEF
INB08A 16S-*	27.6	13.49	60.32	32.0	30.17	7/8-20 UNEF
INB08A 16-*	27.6	18.26	65.07	32.0	30.17	7/8-20 UNEF
INB08A 18-*	31.1	18.26	68.27	36.5	33.32	1-20 UNEF
INB08A 20-*	34.5	18.26	76.98	39.9	34.92	1 3/16-18 UNEF
INB08A 22-*	37.7	18.26	76.98	43.1	34.92	1 3/16-18 UNEF
INB08A 24-*	41.2	18.26	86.51	46.5	39.67	1 7/16-18 UNEF
INB08A 28-*	47.0	18.26	86.51	53.4	39.67	1 7/16-18 UNEF
INB08A 32-*	53.7	18.26	95.25	60.1	47.62	1 3/4-18 UNS
INB08A 36-*	59.90	18.26	100.2	66.3	52.37	2-18 UNS

I/MS3057-■ ■ A Cable Clamp

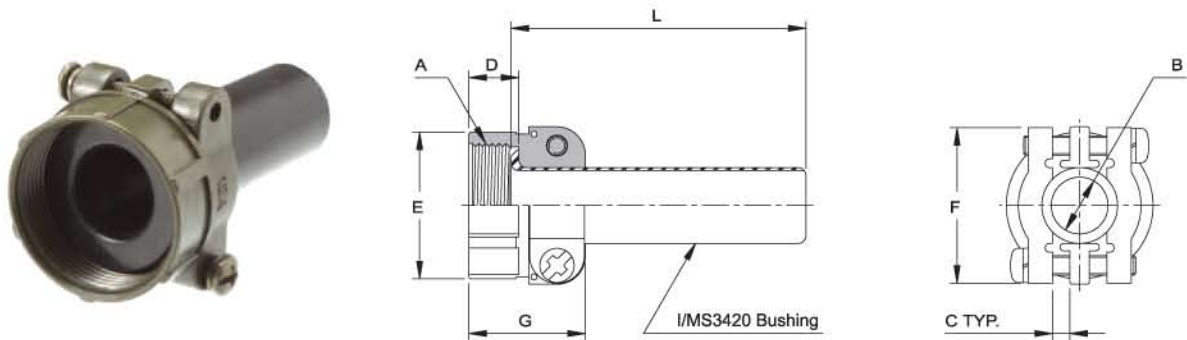

Part No.	Connector Shell Size	A Thread Class 2B	B dia ±0.41	C TYP	D	E dia. ±0.79	F ±0.79	G ±0.79	L Ref.	Bushing Ref.
I/MS3057 - 4A	10SL, 12S & 12	5/8-24 UNEF	5.59	1.57	10.31	20.62	22.23	20.62	69.9	MS3420 - 4
I/MS3057 - 6A	14S & 14	3/4-20 UNEF	7.92	1.98	10.31	24.61	26.97	22.22	66.7	MS3420 - 6
I/MS3057 - 8A	16S & 16	7/8-20 UNEF	11.10	2.77	10.31	27.79	29.36	23.82	63.5	MS3420 - 8
I/MS3057 - 10A	18	1-20 UNEF	14.27	3.18	10.31	30.18	31.75	23.82	60.3	MS3420 - 10
I/MS3057 - 12A	20, 22	1 3/16-18 UNEF	15.88	3.96	10.31	34.93	37.31	23.82	57.2	MS3420 - 12
I/MS3057 - 16A	24, 28	1 7/16-18 UNEF	19.05	4.78	10.31	42.06	42.88	26.18	54.0	MS3420 - 16
I/MS3057 - 20A	32	1 3/4-18 UNS	23.80	6.35	11.91	51.59	51.59	27.78	50.8	MS3420 - 20
I/MS3057 - 24A	36	2-18 UNS	31.75	7.54	13.49	56.36	57.94	29.36	47.6	MS3420 - 24

INB25043 Protective Cover for Receptacles

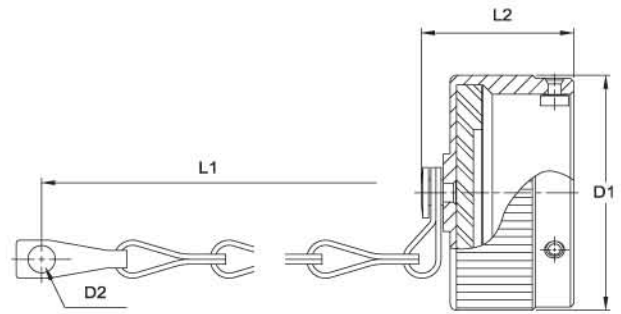

INC Part No.	VG95234 Part No.	Shell Size Connector	D1 dia. max.	D2 dia. +0.6 -0.0	L1 min.	L2 max.
INB25043 - 10SL	VG95234KR10SL	10SL	23.5	4.3	90.0	30.3
INB25043 - 14S	VG95234KR14S	14S	30.5	4.3	90.0	30.0
INB25043 - 16S	VG95234KR16S	16S	33.0	4.3	90.0	30.3
INB25043 - 16	VG95234KR16	16	33.0	4.3	100.0	35.0
INB25043 - 18	VG95234KR18	18	37.5	4.3	100.0	35.0
INB25043 - 20	VG95234KR20	20	41.0	4.3	115.0	35.0
INB25043 - 22	VG95234KR22	22	44.0	4.3	115.0	35.0
INB25043 - 24	VG95234KR24	24	47.5	4.3	115.0	35.0
INB25043 - 28	VG95234KR28	28	54.5	4.3	160.0	35.0
INB25043 - 32	VG95234KR32	32	61.0	4.3	160.0	35.0
INB25043 - 36	VG95234KR36	36	67.5	4.3	160.0	35.0

INB25042 Protective Cover for Plugs

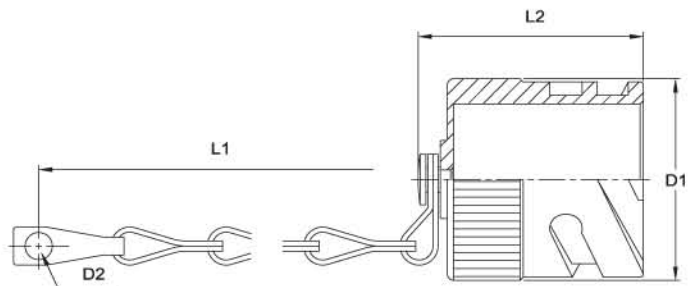

INC Part No.	VG95234 Part No.	Shell Size Connector	D1 dia. max.	D2 dia. +0.6 -0.0	L1 min.	L2 max.
INB25042 - 10SL	VG95234KB10SL	10SL	21.0	4.3	90.0	34.0
INB25042 - 14S	VG95234KB14S	14S	27.5	4.3	100.0	34.0
INB25042 - 16S	VG95234KB16S	16S	30.0	4.3	100.0	34.0
INB25042 - 16	VG95234KB16	16	30.0	4.3	115.0	42.0
INB25042 - 18	VG95234KB18	18	33.5	4.3	115.0	42.0
INB25042 - 20	VG95234KB20	20	37.0	4.7	130.0	42.0
INB25042 - 22	VG95234KB22	22	40.0	4.7	130.0	42.0
INB25042 - 24	VG95234KB24	24	43.5	4.7	130.0	42.0
INB25042 - 28	VG95234KB28	28	49.5	4.7	190.0	42.0
INB25042 - 32	VG95234KB32	32	56.0	4.7	190.0	42.0
INB25042 - 36	VG95234KB36	36	62.5	4.7	190.0	42.0



International
Network —
Connectors

293-4, Hyoseong-dong, Gyeyang-gu, Incheon, Korea
TEL. +82-32-545-1411~3 FAX. +82-32-545-1417